



2 Naomi 2 body

3 Naomi base

4 Naomi 1

5 Naomi 1 body

6 Naomi accessories

Naomi 2 body

Designer

Yaacov Kaufman - 1998

Table lamp in aluminium alloy with a base in steel and aluminium. Extensible and totally pivoting arm; diffuser head can rotate by 360°.

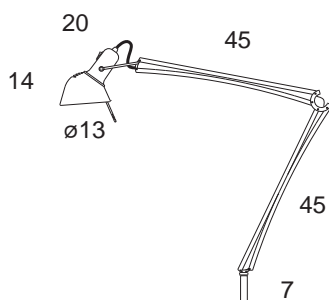

Denominazione - Name - Name **Naomi 2 (cod. 300)**

Certificazioni - Certificates - Prüfzeichen 

Normative - Norms - Normen **EN 60-598-1 (CEI 34-21)**

Lampadina - Light sources - Leuchtmittel **MAX 60W I - 75W HAL - 15W FL EL - E27/E26 (not included)**

Versioni - Available - Versionen **230V (Europe) - 120V (USA - Japan) - 240V (England)**
(fittings come with appropriate plug)

Classe di isolamento - Insulation Class - Isolierungsklasse **II**

Classe di protezione - Protection Class - Protektionsgrad **IP20**

Imballo - Packaging - Verpackung **0,055m³ - 2,25Kg**



Col. 01
Nero
Black
Schwarz



Col. 08
Alluminio anodizzato
Anodised aluminium
Eloxiertes Aluminium



Col. 22
Alluminio lucido
Polished aluminium
Aluminium poliert



Cod. 305
Naomi Terra body



Cod. 310
Naomi 1

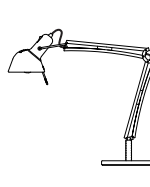

Cod. 315
Naomi Baby

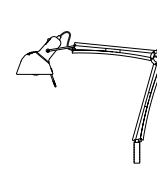

Cod. 316
Naomi Baby body



Cod. 325
Naomi 1 body

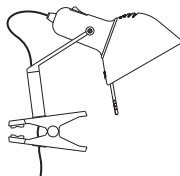

Cod. 328
Naomi Pinza

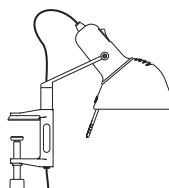

Cod. 329
Naomi Morsetto

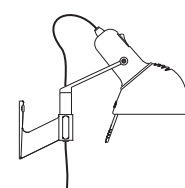

Cod. 330
Naomi Parete

Naomi base

Designer

Yaacov Kaufman - 1998

Base, dedicated to Naomi 2 and Naomi Terra, made of steel.

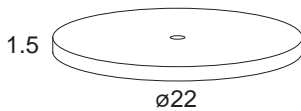

Denominazione - Name - Name **Naomi base (cod. 310)**

Certificazioni - Certificates - Prüfzeichen 

Imballo - Packaging - Verpackung **0,003m³ - 4,5Kg**



Col. 01
Nero
Black
Schwarz

For body finish:



Col. 01
Nero
Black
Schwarz



Col. 33
Cromato
Chromed
Chrom

For body finish:



Col. 22
Alluminio lucido
Polished aluminium
Aluminium poliert



Col. 34
Spazzolato zaponato
Brushed
Gebürstet

For body finish:



Col. 08
Alluminio anodizzato
Anodised aluminium
Eloxiertes Aluminium

Naomi 1

Designer

Yaacov Kaufman - 1998

Table lamp in aluminium alloy with a base in steel and aluminium. Extensible and totally pivoting arm; diffuser head can rotate by 360°.

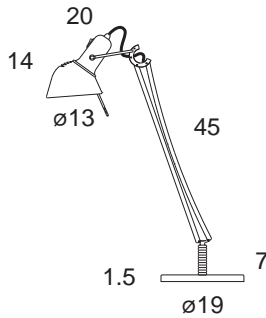

Denominazione - Name - Name **Naomi 1 (cod. 320)**

Certificazioni - Certificates - Prüfzeichen **CE**

Normative - Norms - Normen **EN 60-598-1 (CEI 34-21)**

Lampadina - Light sources - Leuchtmittel **MAX 60W I - 75W HAL - 15W FL EL - E27/E26 (not included)**

Versioni - Available - Versionen **230V (Europe) - 120V (USA - Japan) - 240V (England)**
(fittings come with appropriate plug)

Classe di isolamento - Insulation Class - Isolierungsklasse **II**

Classe di protezione - Protection Class - Protektionsgrad **IP20**

Imballo - Packaging - Verpackung **0,036m³ - 5,0Kg**



Col. 01
Nero
Black
Schwarz



Col. 08
Alluminio anodizzato
Anodised aluminium
Eloxiertes Aluminium



Col. 22
Alluminio lucido
Polished aluminium
Aluminium poliert

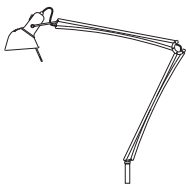

Cod. 300
Naomi 2 body

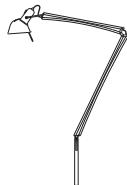

Cod. 305
Naomi Terra body

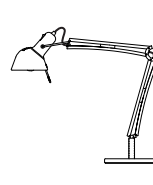

Cod. 315
Naomi Baby



Cod. 316
Naomi Baby body



Cod. 325
Naomi 1 body

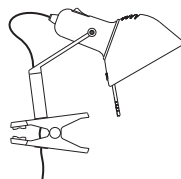

Cod. 328
Naomi Pinza

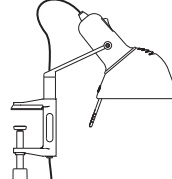

Cod. 329
Naomi Morsetto

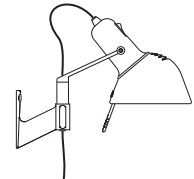

Cod. 330
Naomi Parete

Naomi 1 body

Designer

Yaacov Kaufman - 1998

Lamp in aluminium alloy. Extensible and totally pivoting arm; diffuser head can rotate by 360°.

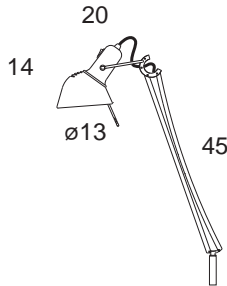

Denominazione - Name - Name	Naomi 1 body (cod. 325)
Certificazioni - Certificates - Prüfzeichen	
Normative - Norms - Normen	EN 60-598-1 (CEI 34-21)
Lampadina - Light sources - Leuchtmittel	MAX 60W I - 75W HAL - 15W FL EL - E27/E26 (not included) 230V (Europe) - 120V (USA - Japan) - 240V (England) <i>(fittings come with appropriate plug)</i>
Versioni - Available - Versionen	
Classe di isolamento - Insulation Class - Isolierungsklasse	II
Classe di protezione - Protection Class - Protektionsgrad	IP20
Imballo - Packaging - Verpackung	0,036m³ - 1,61Kg



Col. 01
Nero
Black
Schwarz



Col. 08
Alluminio anodizzato
Anodised aluminium
Eloxiertes Aluminium



Col. 22
Alluminio lucido
Polished aluminium
Aluminium poliert

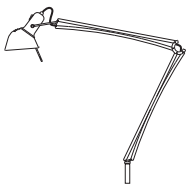

Cod. 300
Naomi 2 body

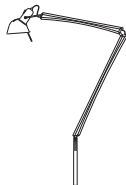

Cod. 305
Naomi Terra body

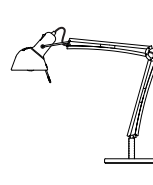

Cod. 315
Naomi Baby

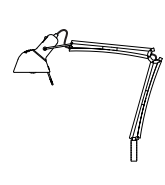

Cod. 316
Naomi Baby body

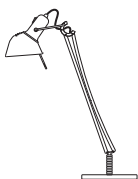

Cod. 320
Naomi 1

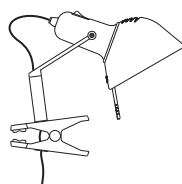

Cod. 328
Naomi Pinza

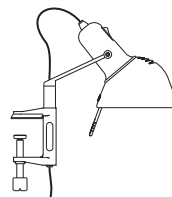

Cod. 329
Naomi Morsetto

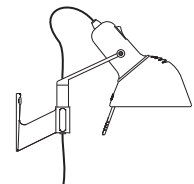

Cod. 330
Naomi Parete

Clamp-on cod. 112

Tangram/Naomi

Clamp on, dedicated to Tangram and Naomi, made out of die-cast aluminium and steel.

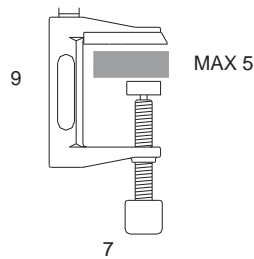

Imballo - Packaging - Verpackung **0,005m³ - 0,28Kg**



Col. 08

Alluminio anodizzato
Anodised aluminium
Eloxiertes Aluminium

Wall attachment cod. 113

Tangram/Naomi

Wall attachment, dedicated to Tangram and Naomi, made out of die-cast aluminium.

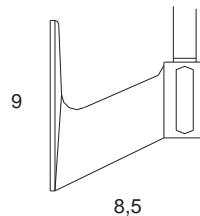

Imballo - Packaging - Verpackung **0,005m³ - 0,22Kg**



Col. 08

Alluminio anodizzato
Anodised aluminium
Eloxiertes Aluminium

Table mount cod. 332

Tangram/Naomi

Table mount, dedicated to Tangram and Naomi, made out of aluminium.

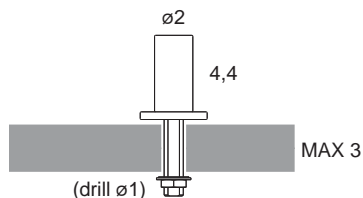

Imballo - Packaging - Verpackung **0,002m³ - 0,16Kg**



Col. 22

Alluminio lucido
Polished aluminium
Aluminium poliert