

1 tap hole
1 drain hole

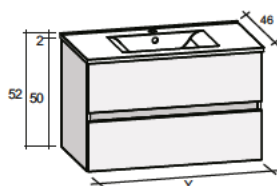

Y 600-800-1000mm

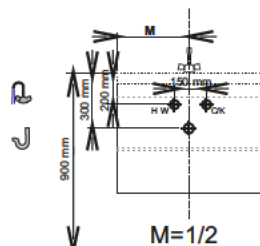

2 tap holes
2 drain holes

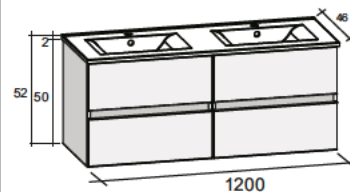

Y= 1200mm

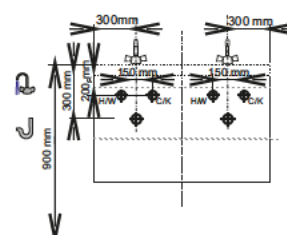

Remove drawer

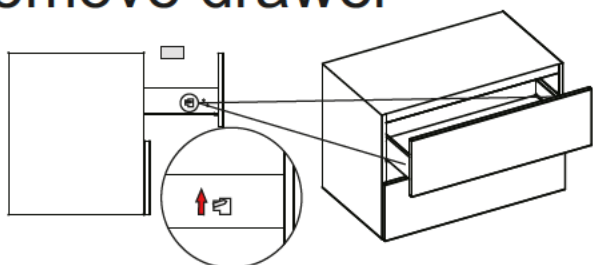

Remove front

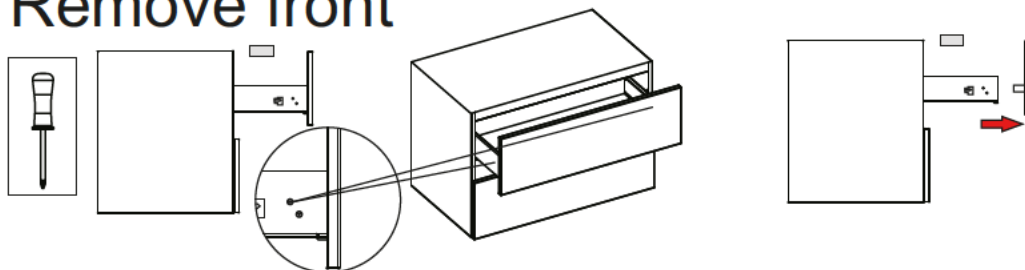

Adjust height

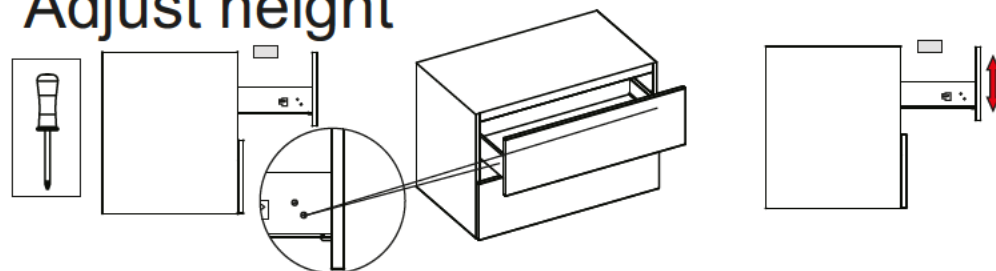

Adjust left-right

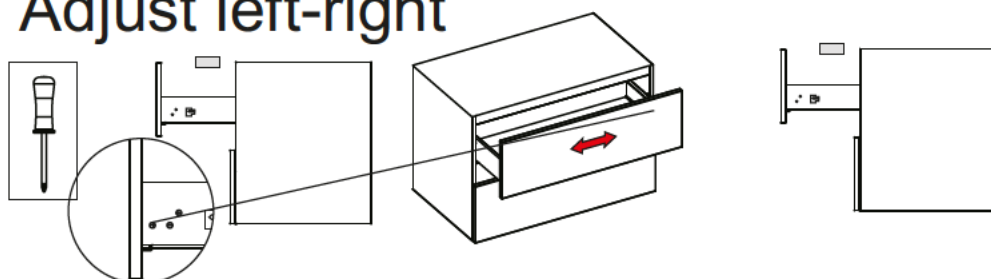

Wall mount:

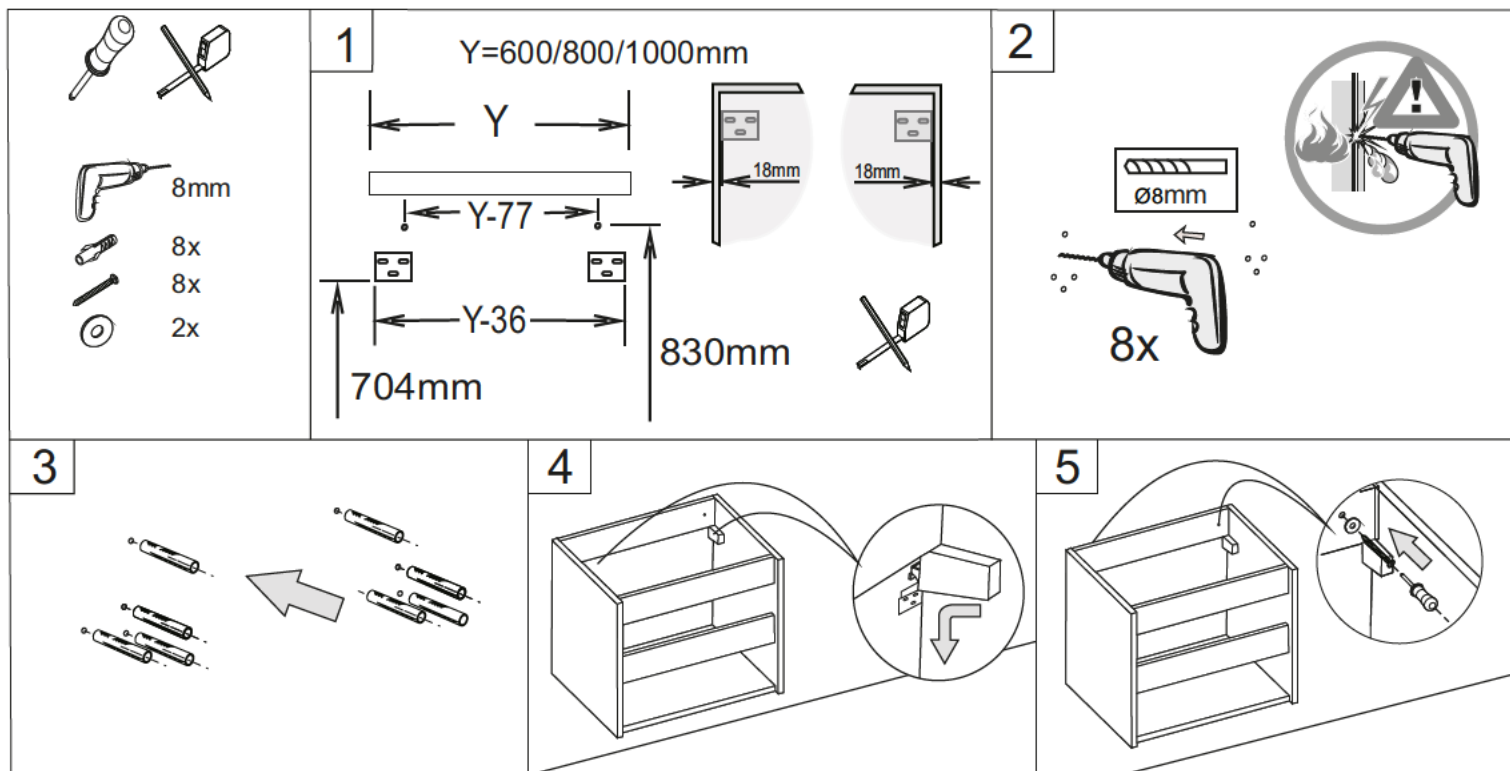

Built - in led driver

